

# FECOM

THIRD ANGLE  
PROJECTION

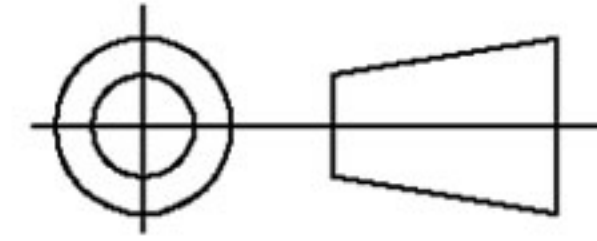

REMOVE ALL BURRS  
& SHARP EDGES

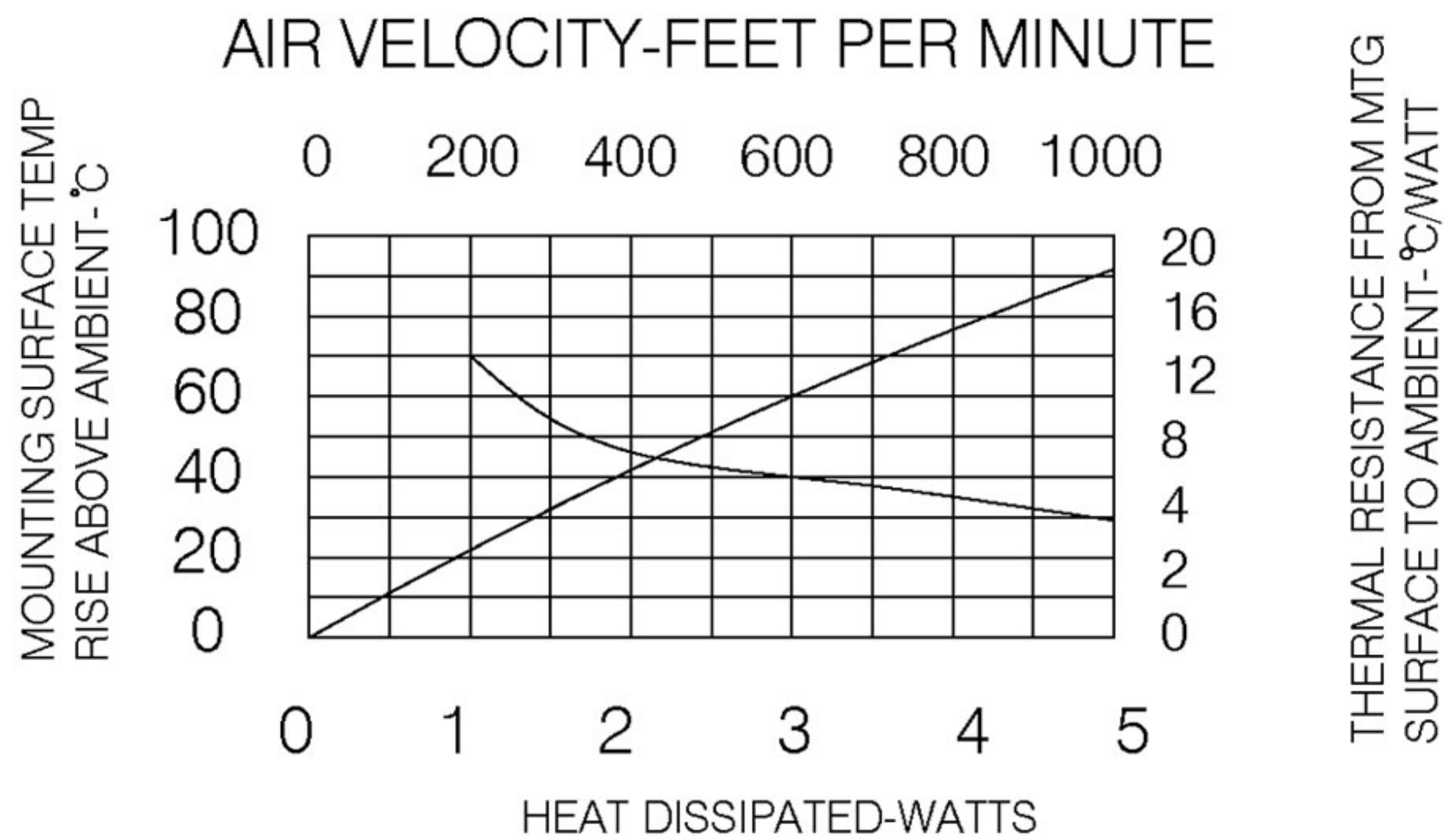
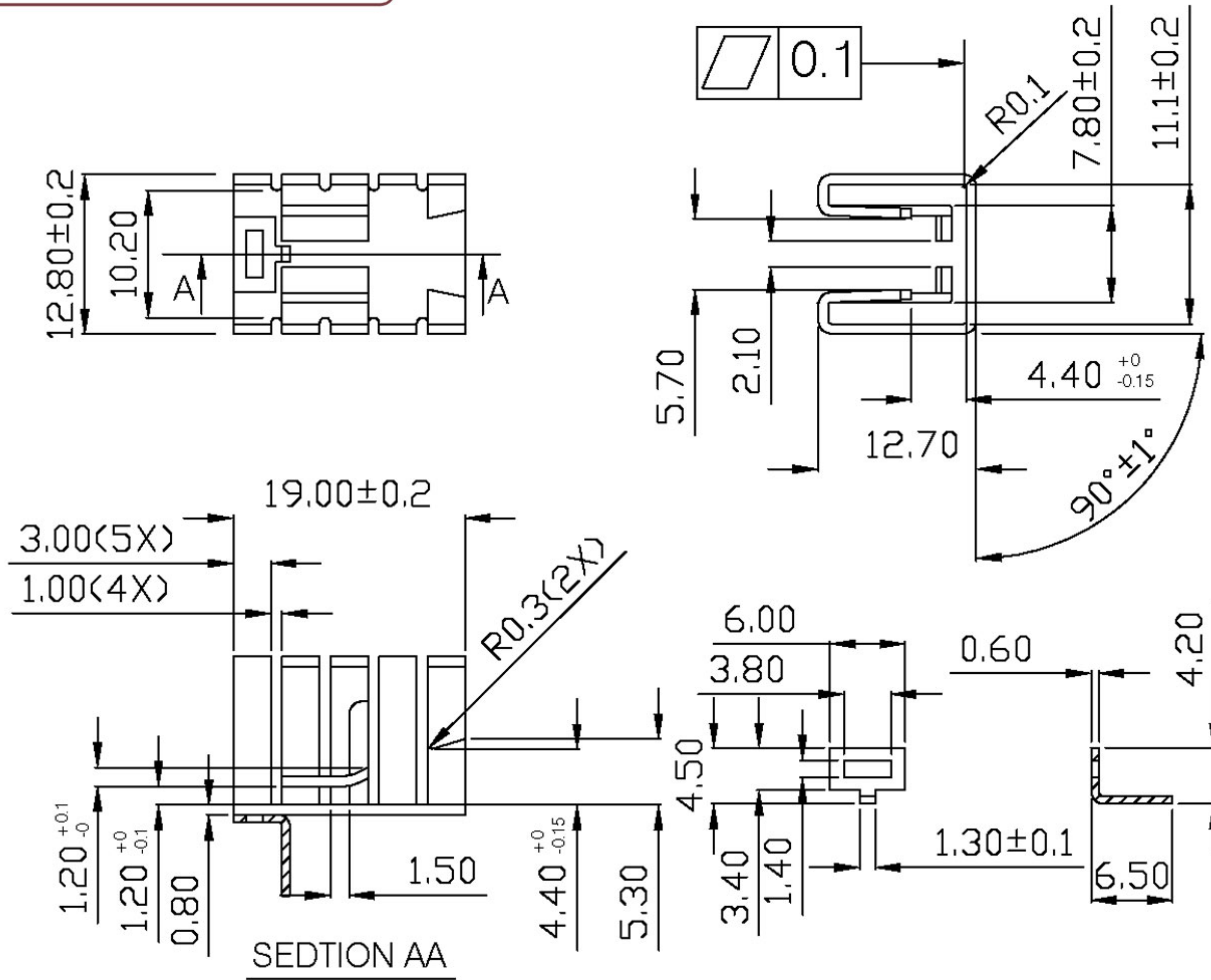

TOLERANCE  
UNIT ±0.5  
.0 ±0.  
.00 ±0.0  
.000 ±0.00

MATERIAL: AL5052

FINISH: BLACK ANODIZE

HEAT SINK

FECOM P/N: FE-T220-0060-02