

FECOM

THIRD ANGLE
PROJECTION

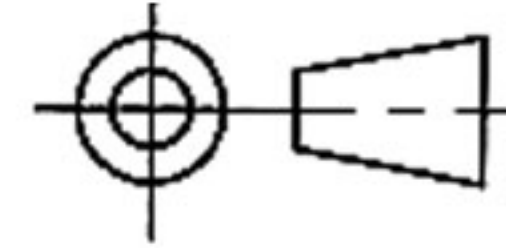

REMOVE ALL BURRS
& SHARP EDGES

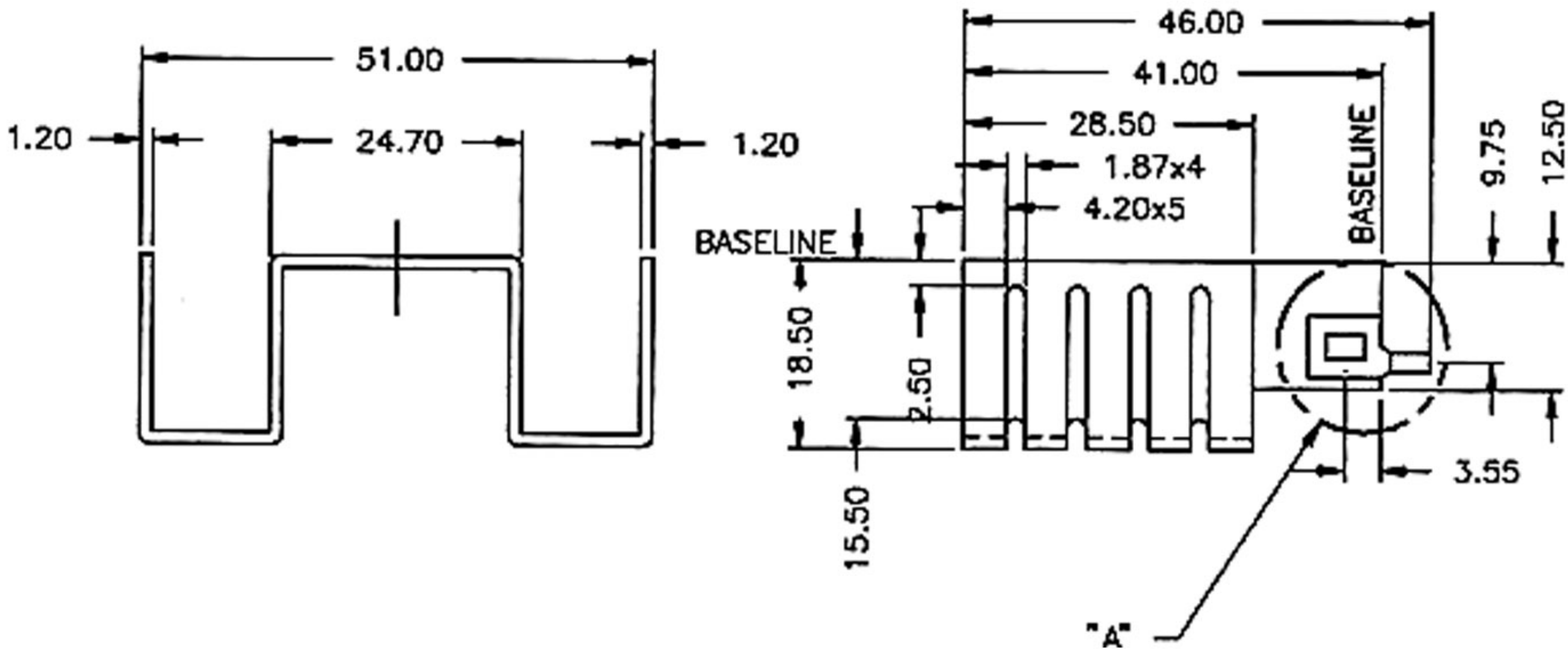
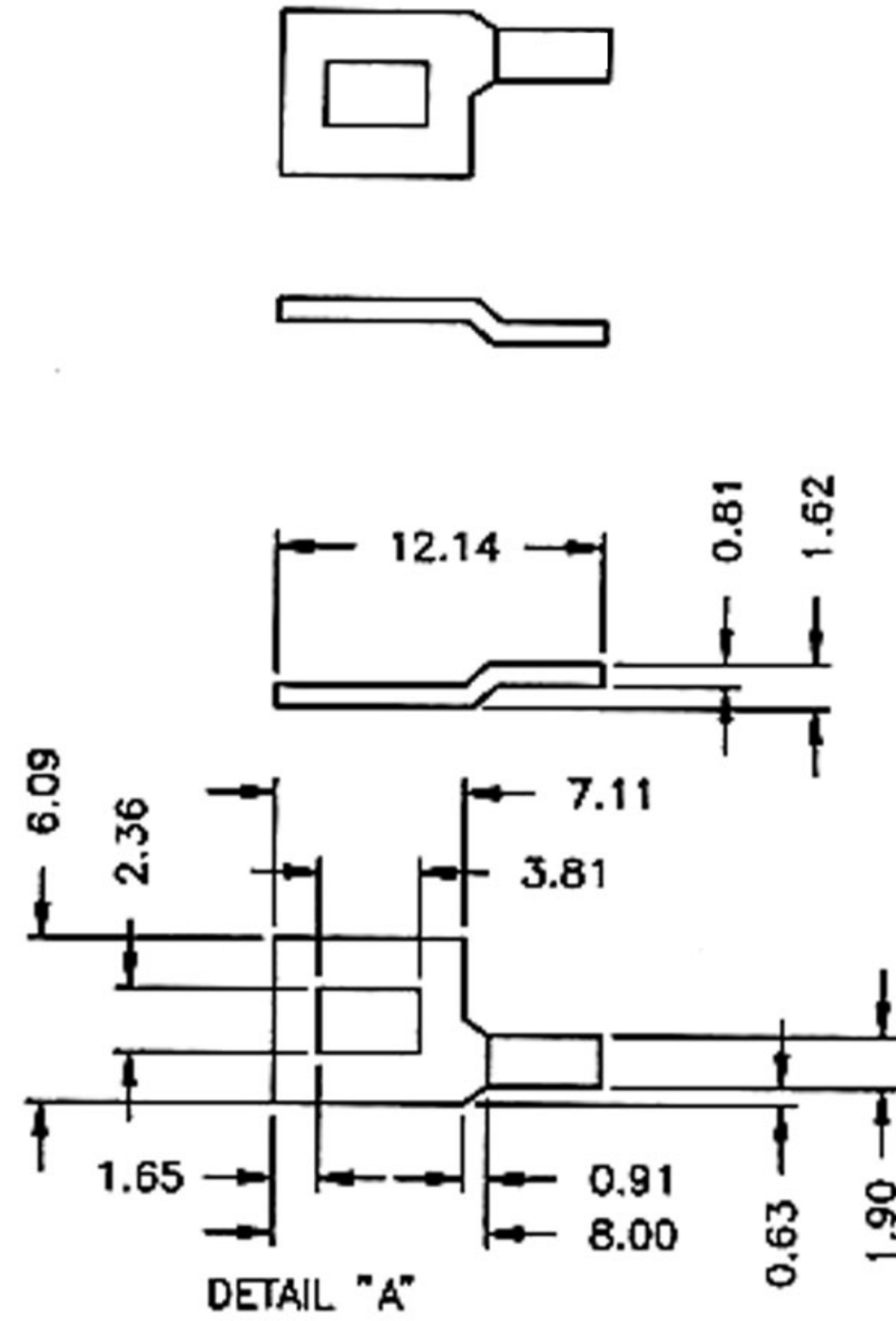
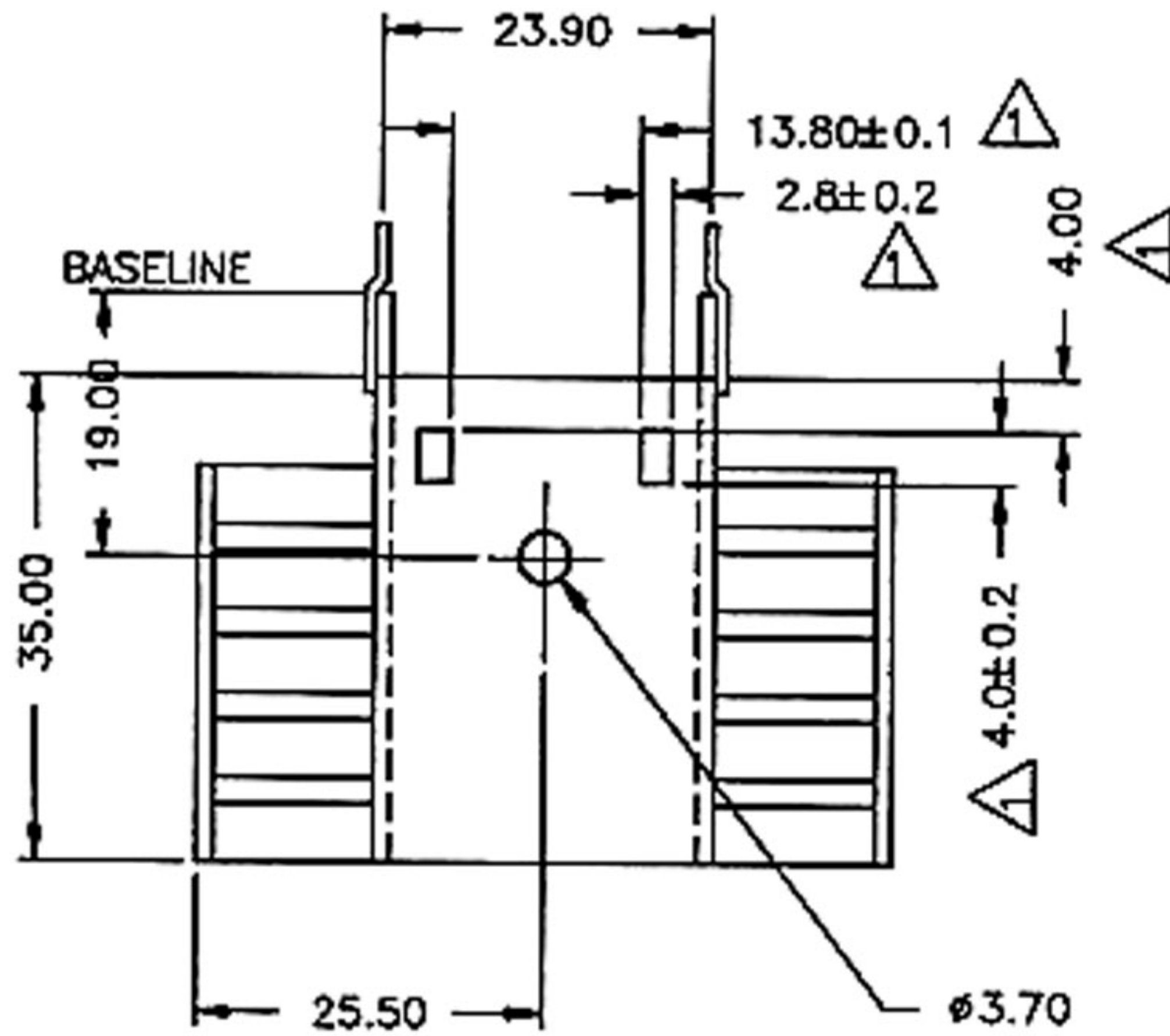

MATERIAL: AL1100

FINISH: BLACK ANODIZE

HEAT SINK

FECOM P/N: FE-T220-0052-02